

# Příklady funkcí

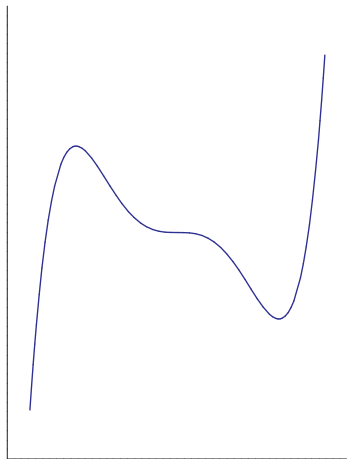

# Příklady funkcí

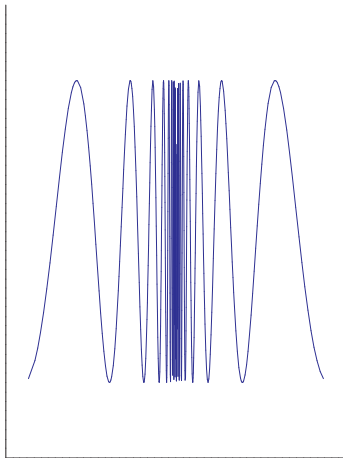
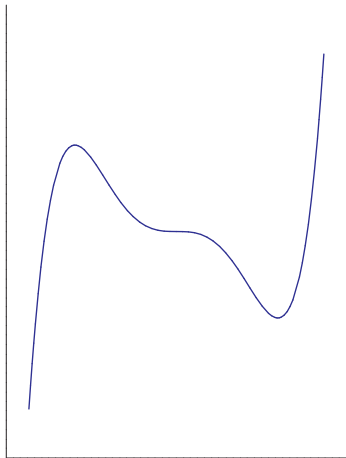

# Příklady funkcí

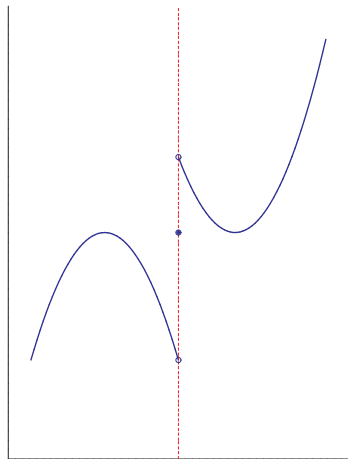

# Příklady funkcí

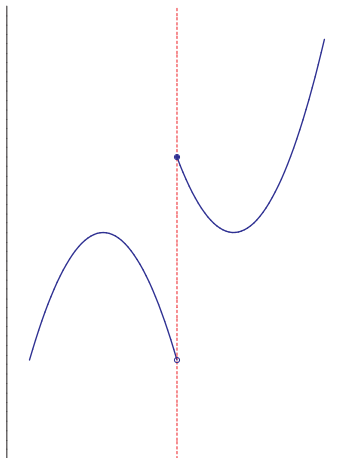
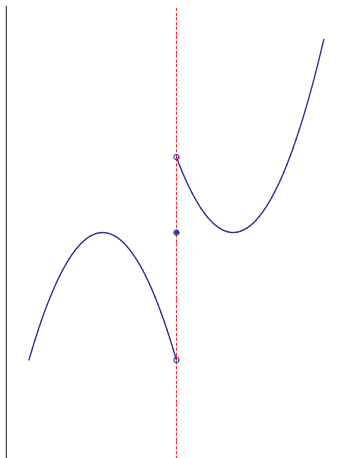

# Příklady funkcí

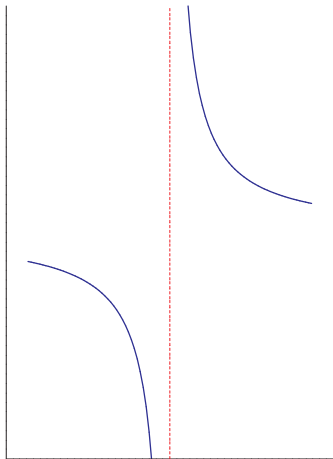

# Příklady funkcí

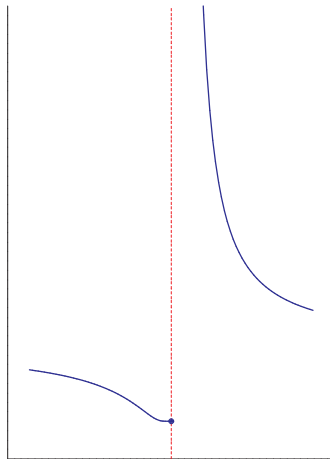
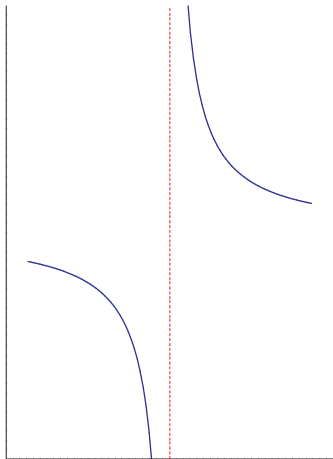

# spojitost funkce v bodě – definice

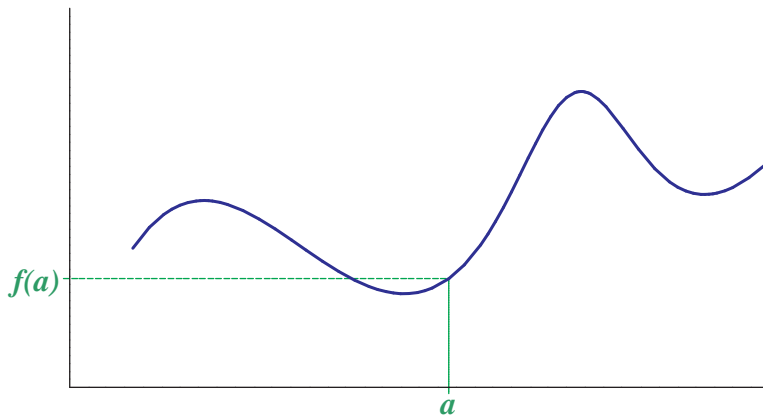

# spojitost funkce v bodě – definice

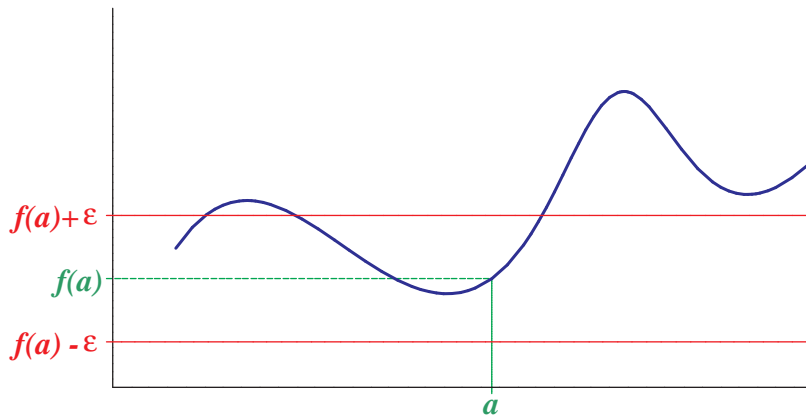



# spojitost funkce v bodě – definice

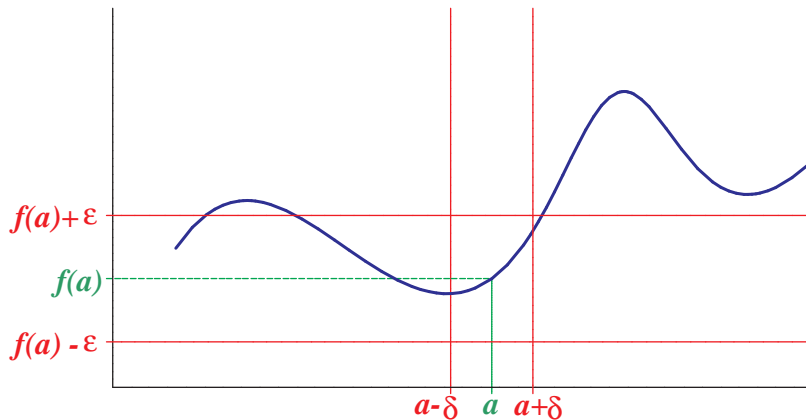

# spojitost funkce v bodě – definice

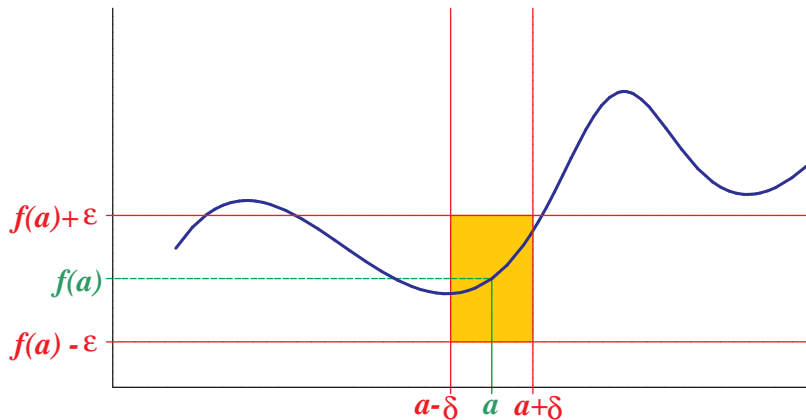

# spojitost funkce v bodě – definice

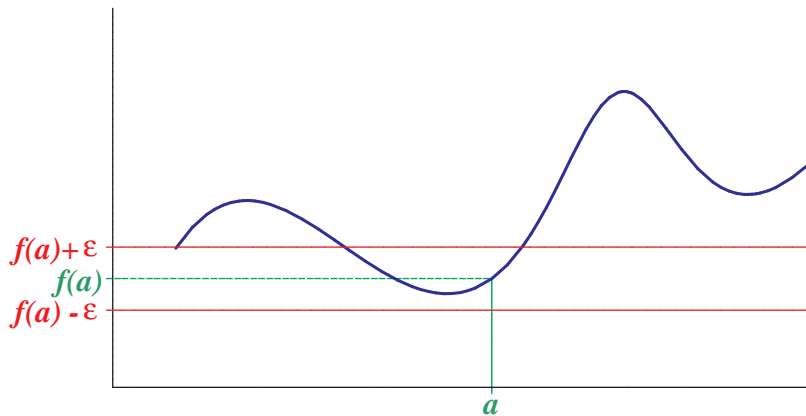

# spojitost funkce v bodě – definice

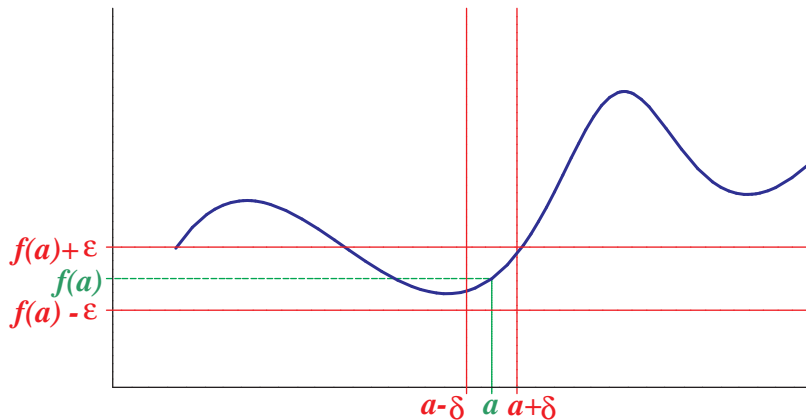

# spojitost funkce v bodě – definice

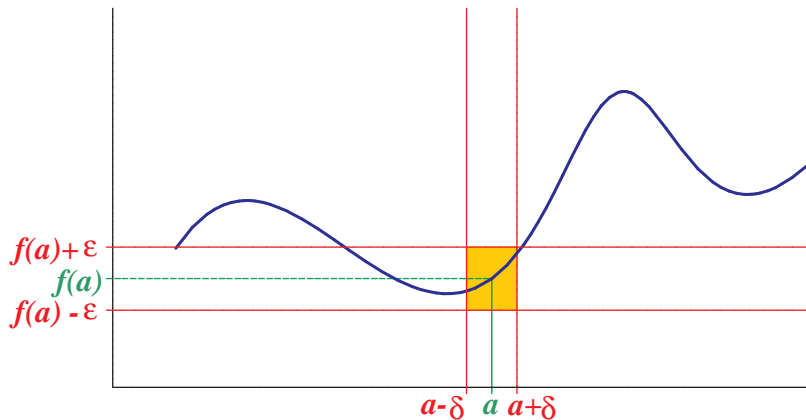

# spojitost funkce v bodě – definice

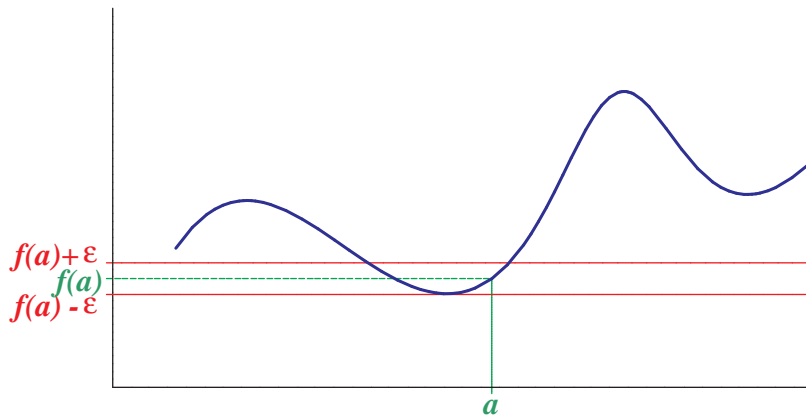

# spojitost funkce v bodě – definice

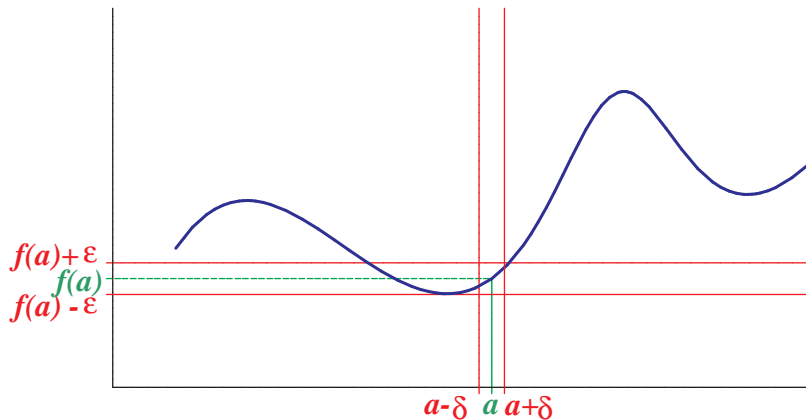

# spojitost funkce v bodě – definice

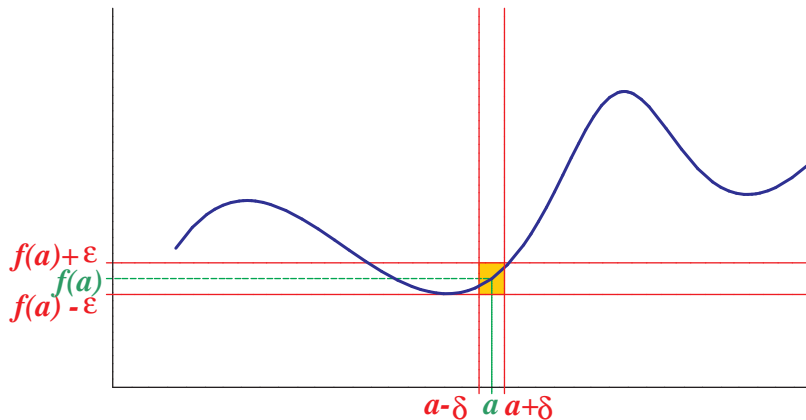



# Spojitosť konstantní funkce

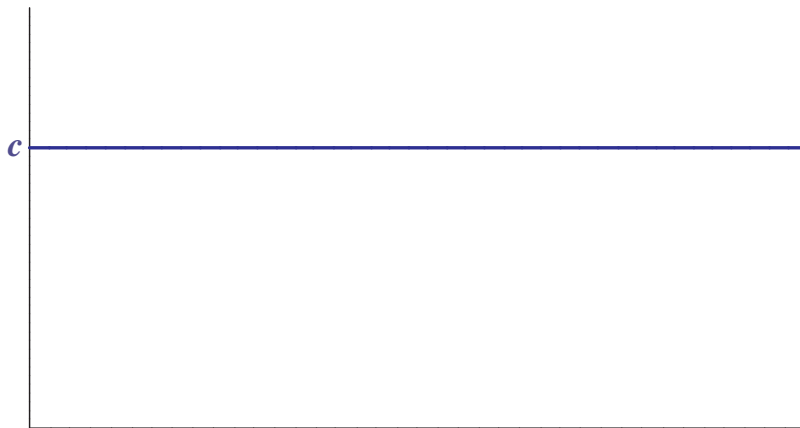

# Spojitosť konstantní funkce

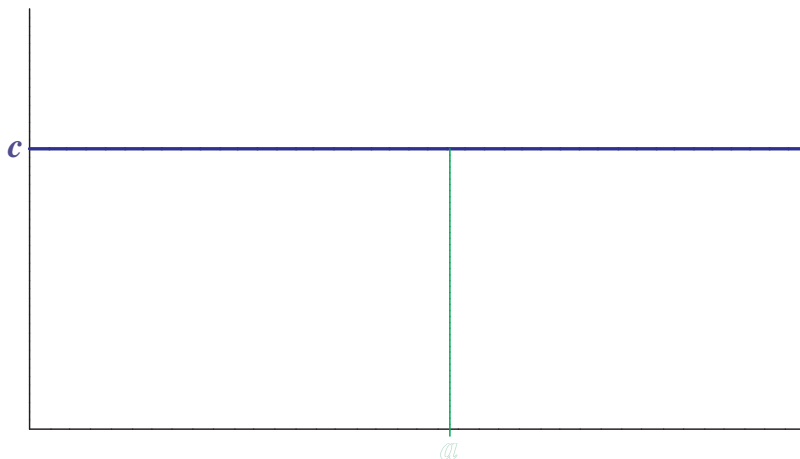

# Spojitosť konstantní funkce

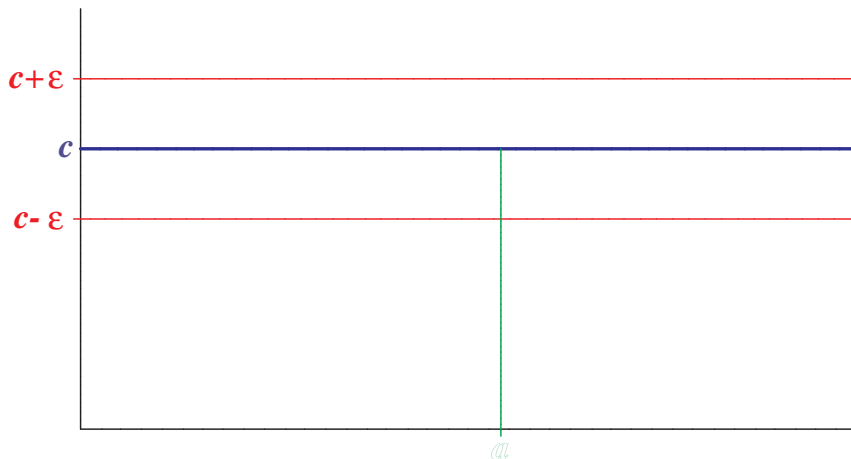

# Spojitosť konstantní funkce

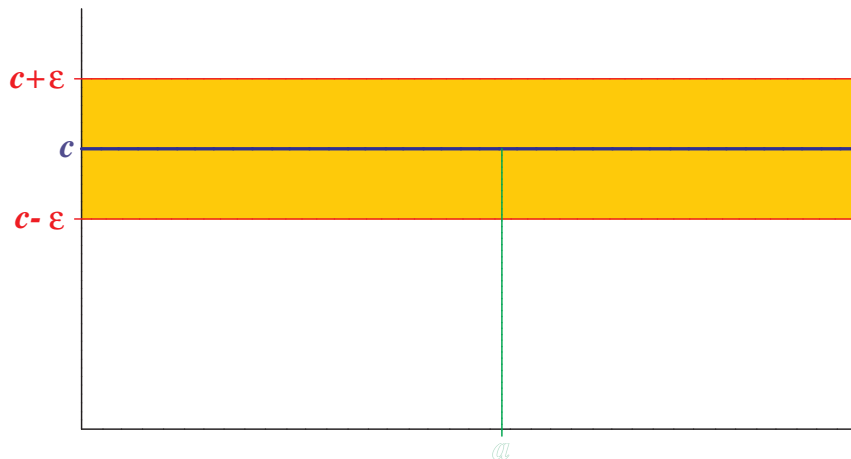

# Spojitosť funkce $f(x) = x$

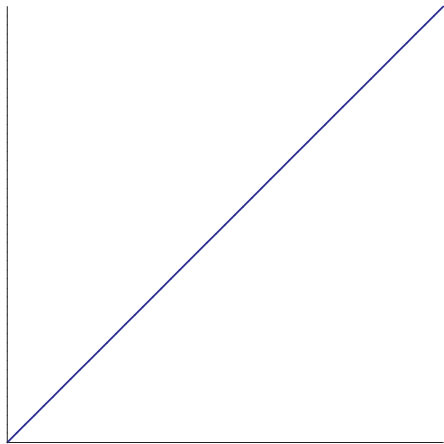

# Spojitosť funkce $f(x) = x$

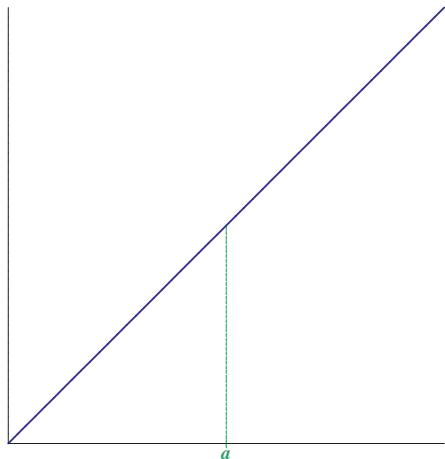

# Spojitosť funkce $f(x) = x$

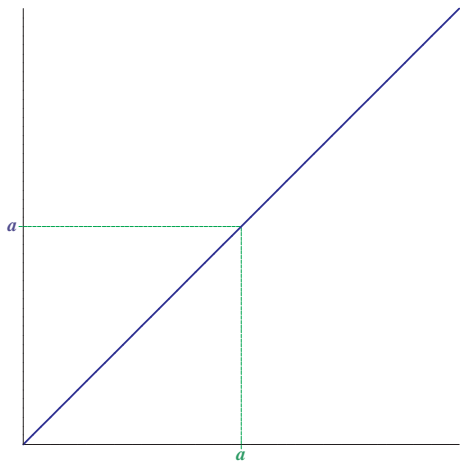

# Spojitosť funkce $f(x) = x$

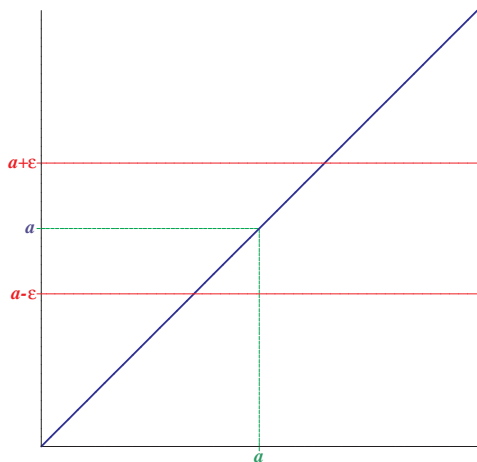



# Spojitosť funkce $f(x) = x$

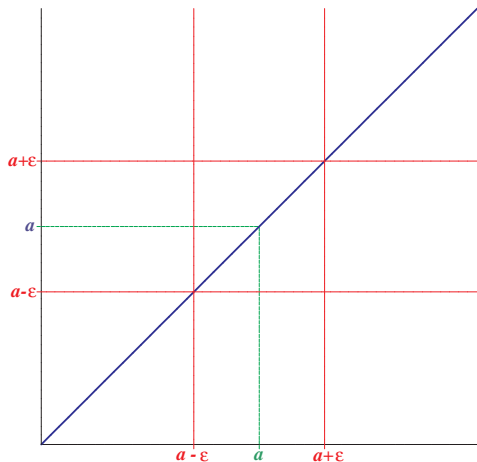

# Spojitosť funkce $f(x) = x$

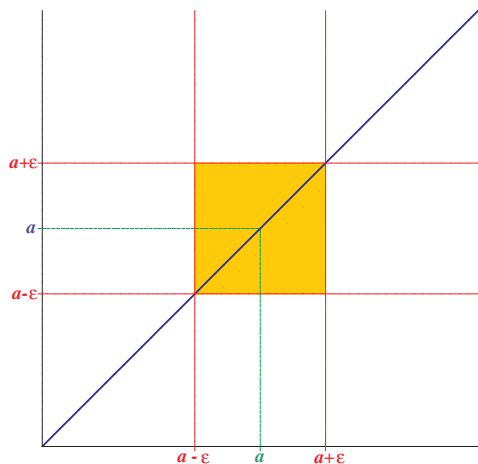

# Nespojitost funkce $\text{sgn}$ v bodě 0

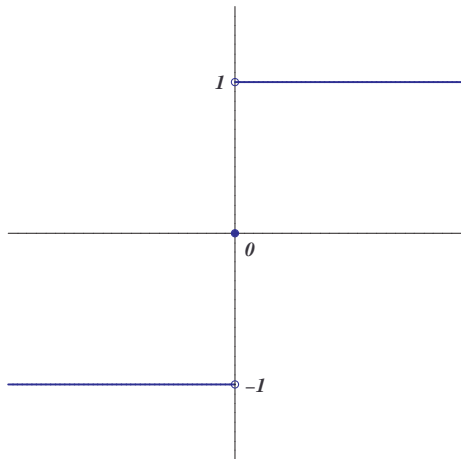

# Nespojitost funkce $\text{sgn}$ v bodě 0

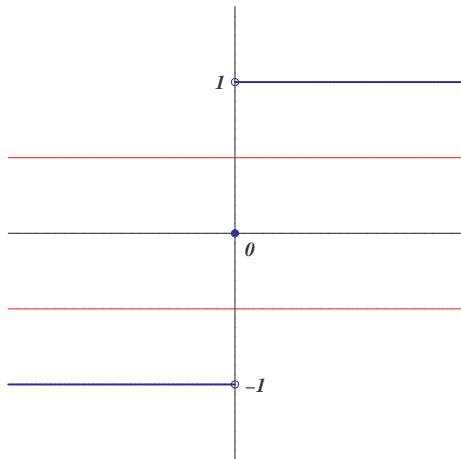

# Nespojitost funkce $\text{sgn}$ v bodě 0

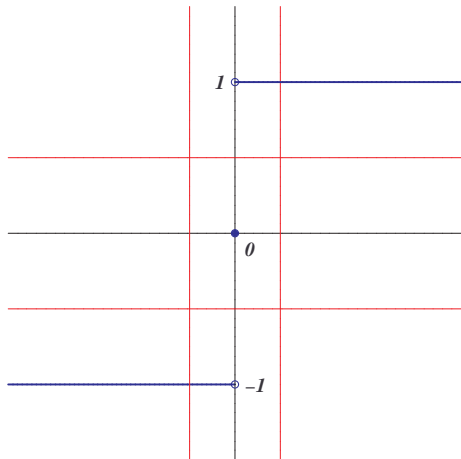

# Nespojitost funkce $\text{sgn}$ v bodě $0$

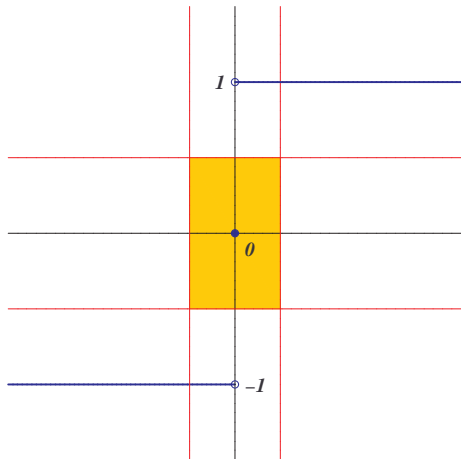

# Nespojitost funkce $\text{sgn}$ v bodě 0

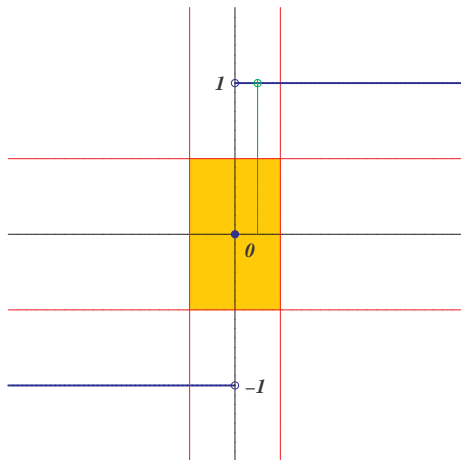

# Limita funkce – definice

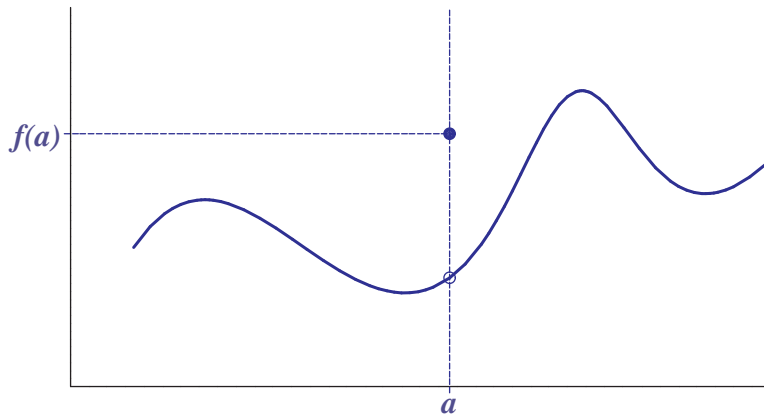



# Limita funkce – definice

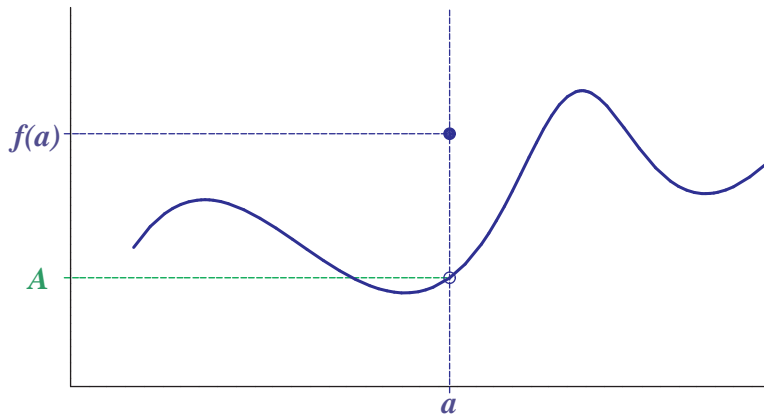

# Limita funkce – definice

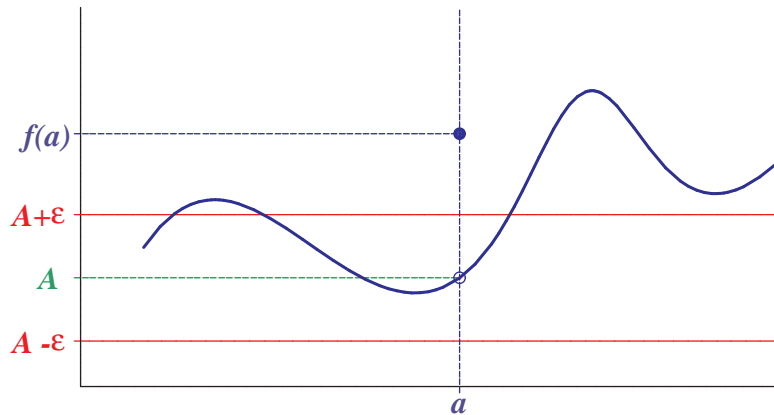

# Limita funkce – definice

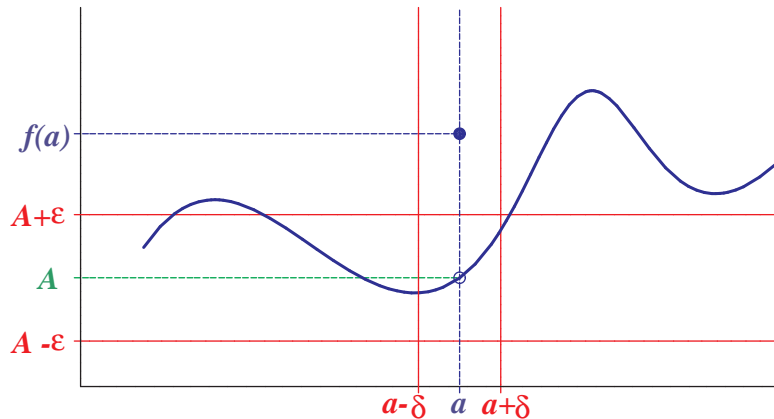

# Limita funkce – definice

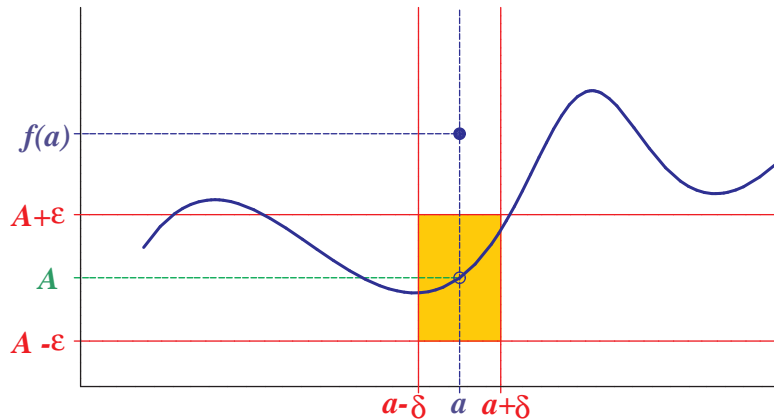

# Limita funkce – definice

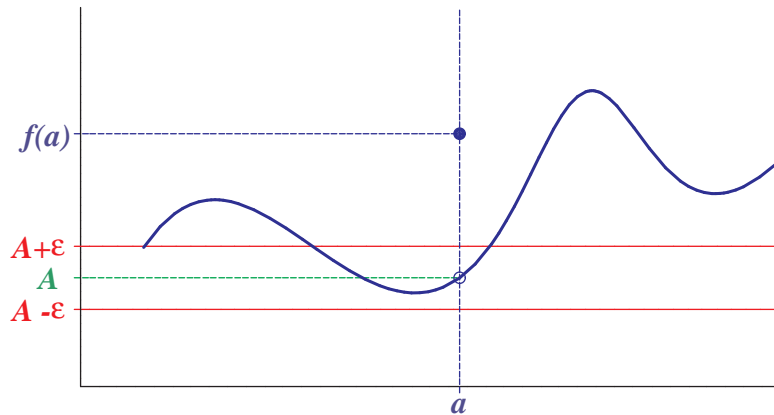

# Limita funkce – definice

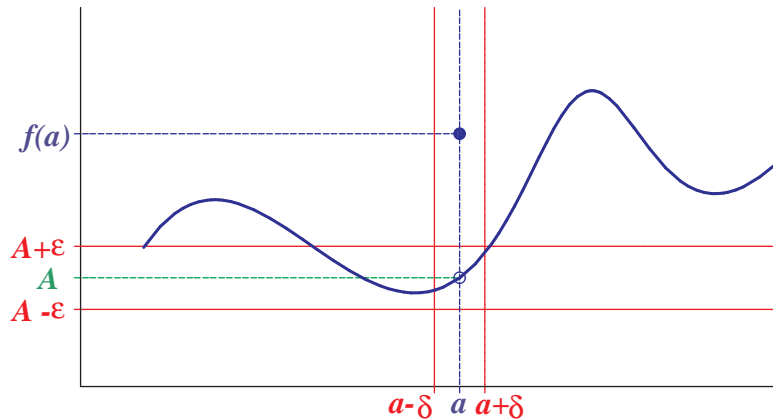

# Limita funkce – definice

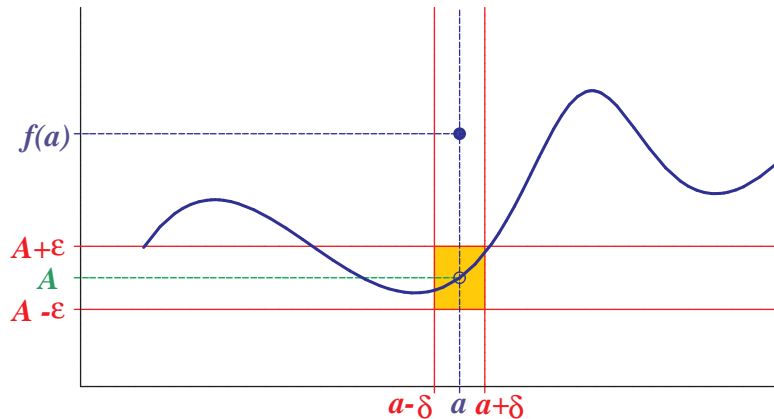

# Spojítost zleva i zprava $\Rightarrow$ spojítost

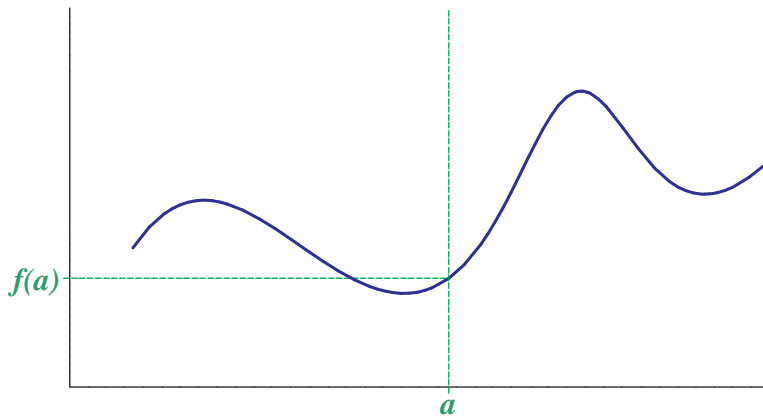



# Spojitosť zleva i zprava $\Rightarrow$ spojitosť

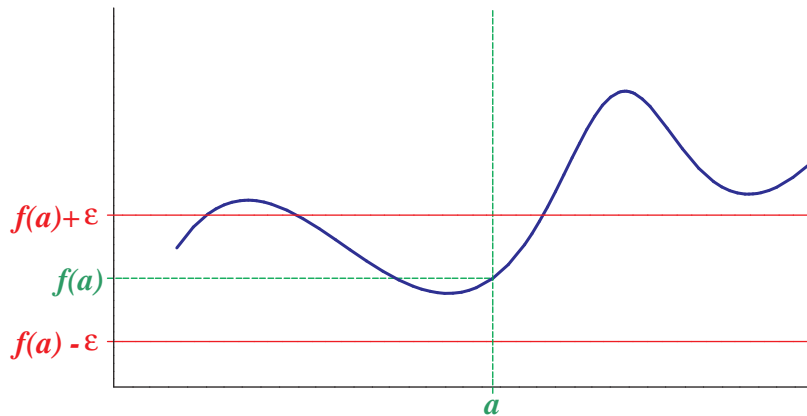

# Spojitosť zleva i zprava $\Rightarrow$ spojitosť

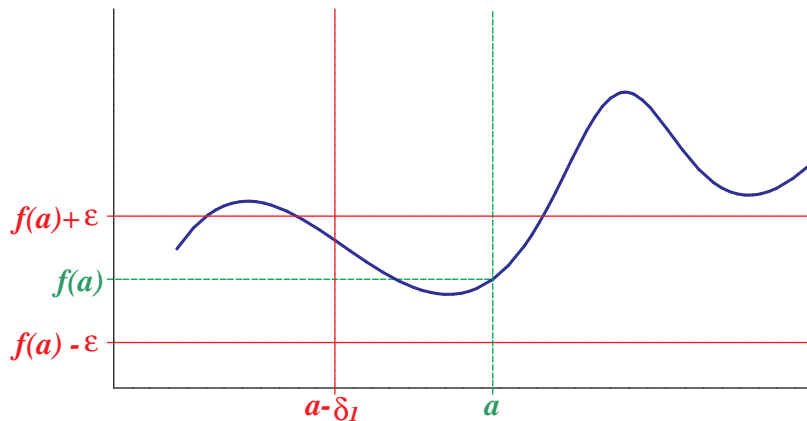

# Spojitosť zleva i zprava $\Rightarrow$ spojitosť

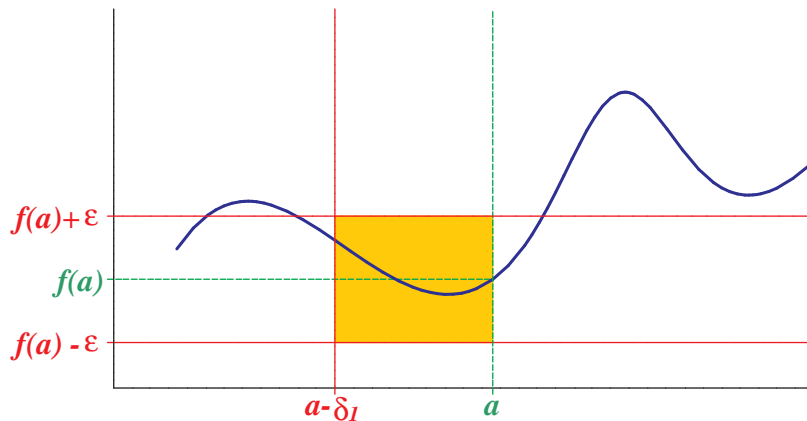

# Spojitosť zleva i zprava $\Rightarrow$ spojitosť

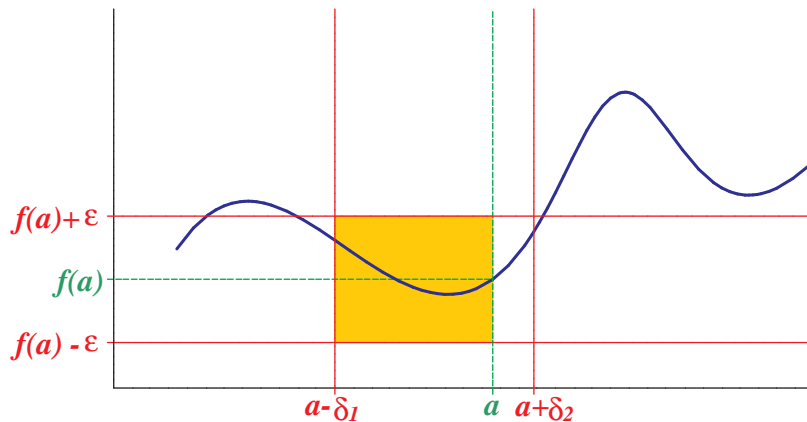

# Spojitosť zleva i zprava $\Rightarrow$ spojitosť

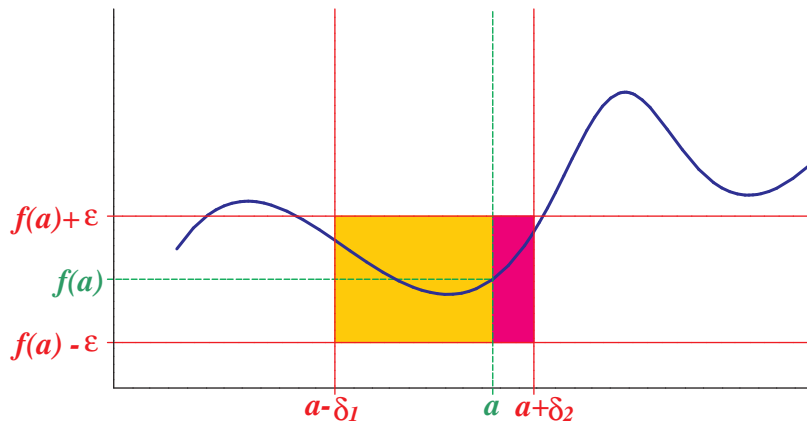

# Spojitosť zleva i zprava $\Rightarrow$ spojitosť

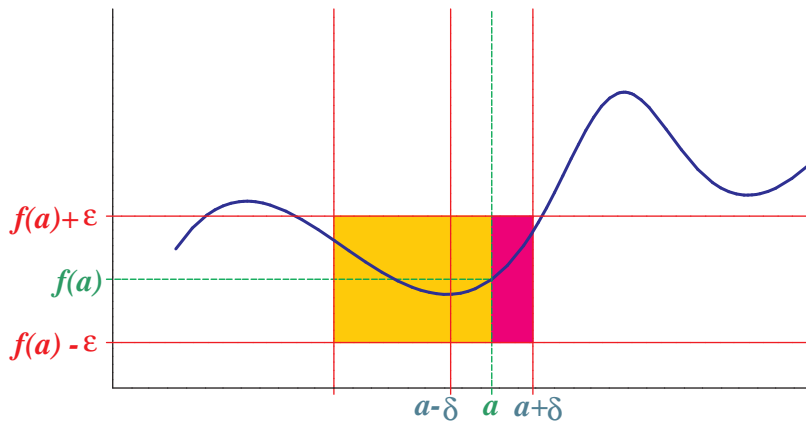

# Spojitosť zleva i zprava $\Rightarrow$ spojitosť

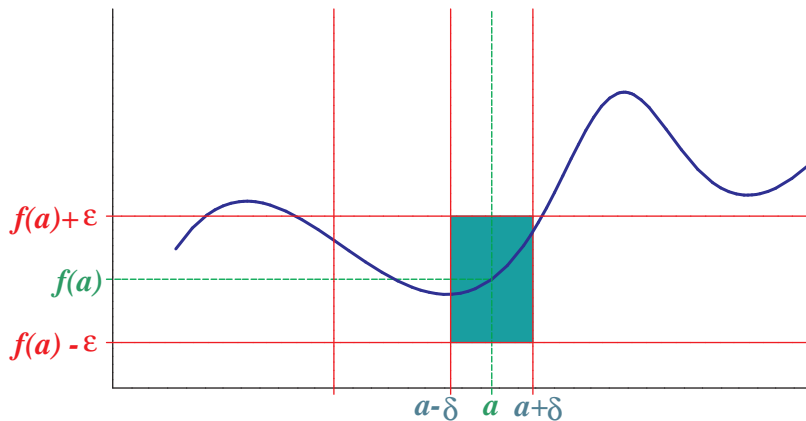

# Jednoznačnost limity funkce

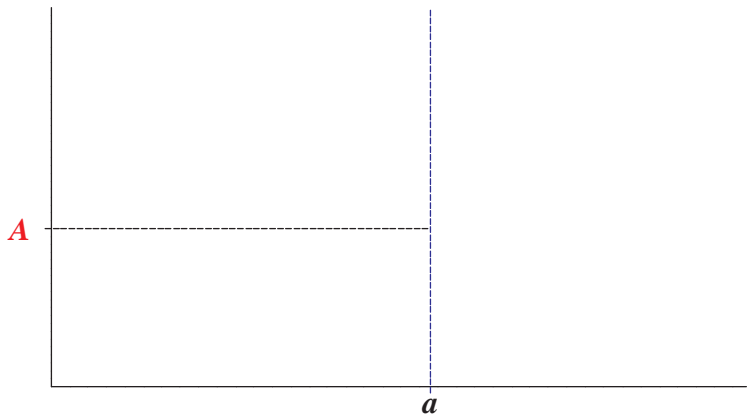



# Jednoznačnost limity funkce

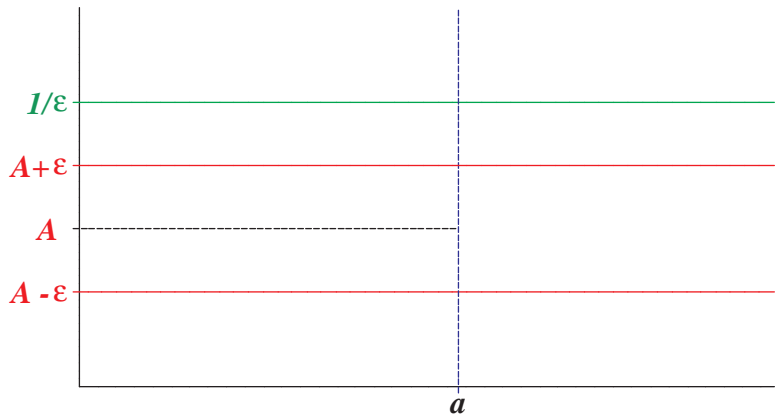

# Jednoznačnost limity funkce

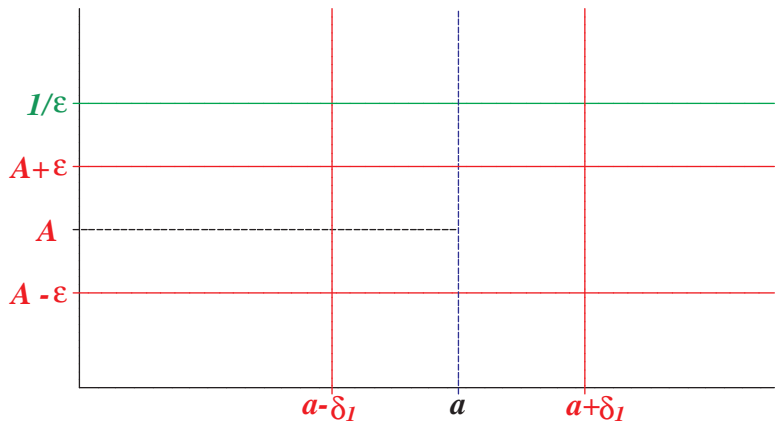

# Jednoznačnost limity funkce

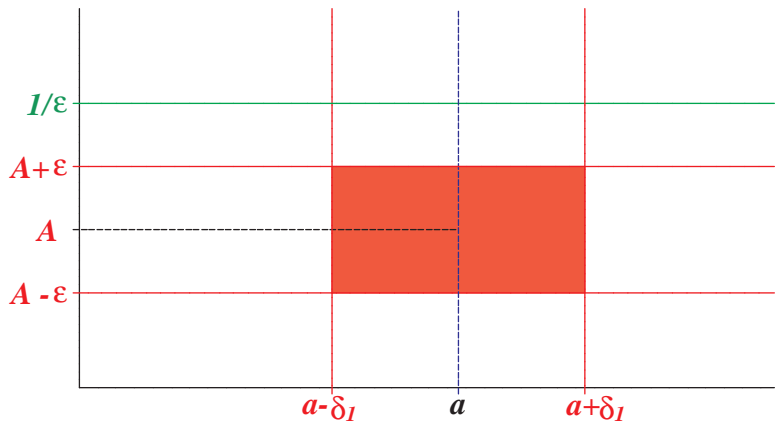

# Jednoznačnost limity funkce

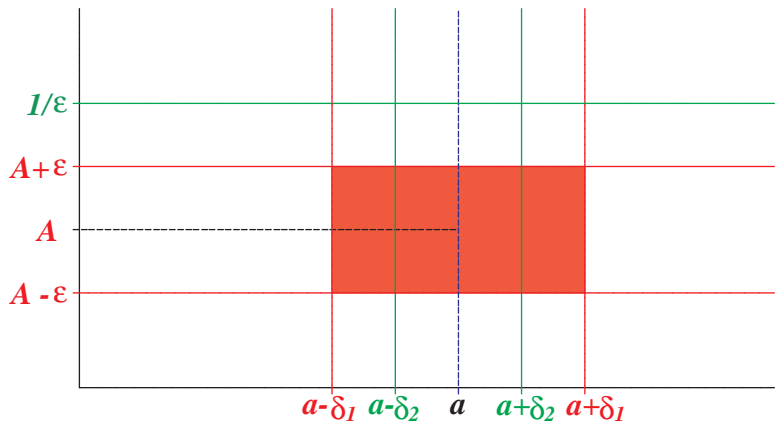

# Jednoznačnost limity funkce

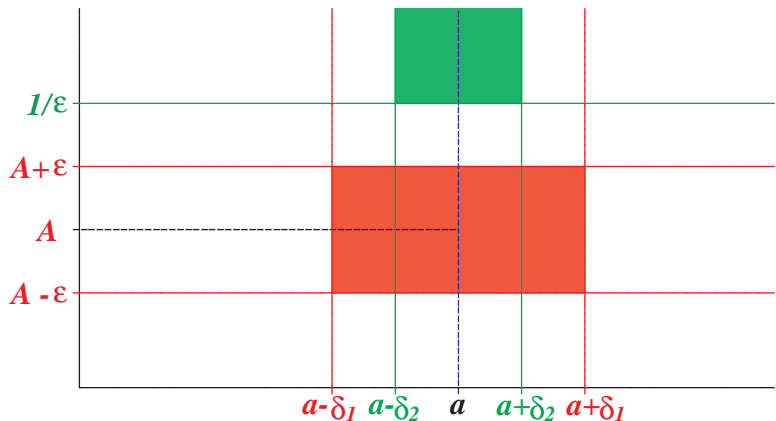

# Jednoznačnost limity funkce

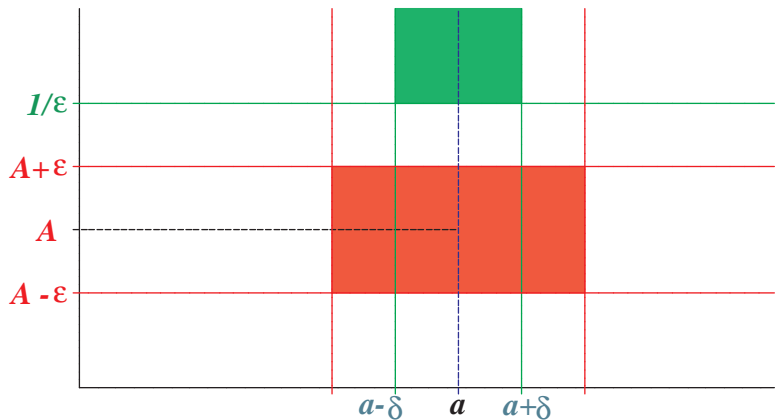

# Jednoznačnost limity funkce

